

# TX-7070W48FSB3-NU3CH-01

## PRODUCT SPECIFICATION

### Features:

- ◆Excellent transiting heat from LED chip operating under 3000\*2 mA.
- ◆Ceramic eutectic package allows it to have minimal internal stress and excellent thermal path.
- ◆Flip chip coated with package, the output of lumen is stable.
- ◆High luminous output.
- ◆Encapsulated materials are environmentally certified and meet environmental requirements.

### Chip Material:

- ◆GaN

### Emitting Color:

- ◆Cold white

### Applications:

- ◆Automobile lighting

Part No.	TX-7070W48FSB3-NU3CH-01	Spec No.	WKF-EK0022	Page	1 of 9
----------	-------------------------	----------	------------	------	--------

**Package Dimensions:**

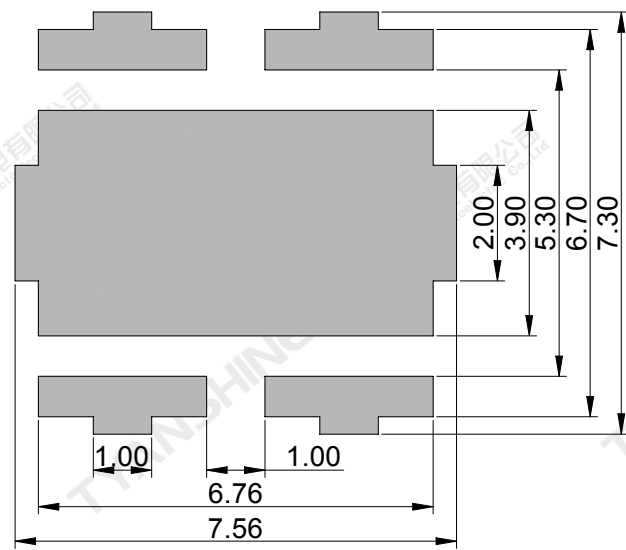
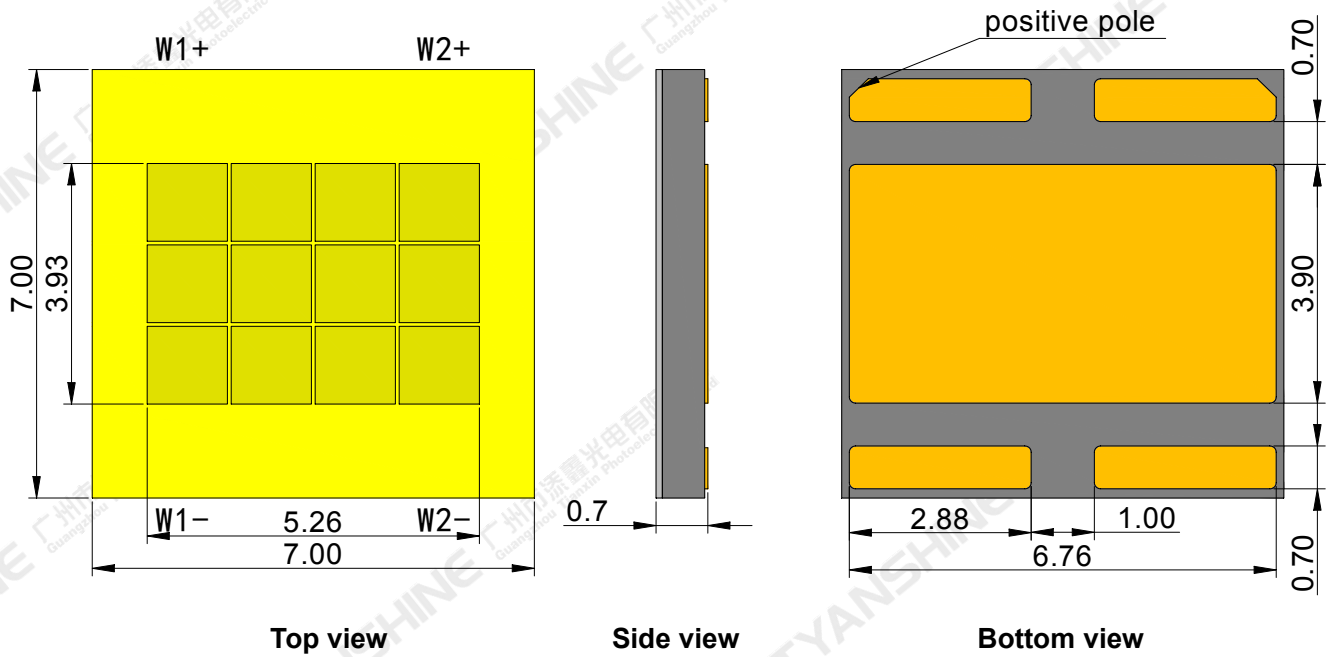

Recommended solder pad

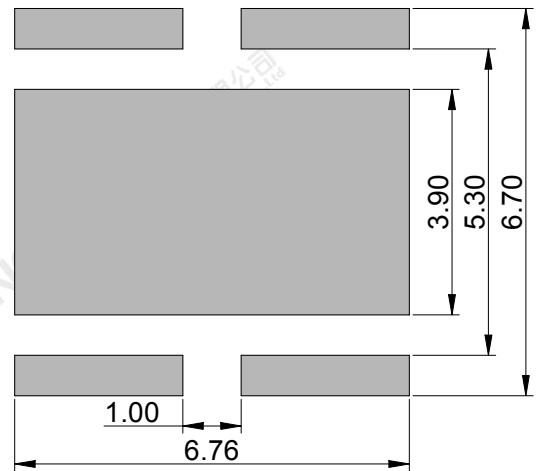

recommended stencil pattern

**Notes:**

- 1.All dimensions are in millimeters .
- 2.Tolerances unless otherwise mentioned are  $\pm 0.1\text{mm}$  .

Part No.	TX-7070W48FSB3-NU3CH-01	Spec No.	WKF-EK0022	Page	2 of 9
----------	-------------------------	----------	------------	------	--------

**Absolute Maximum Ratings (Tc=25°C)**

Parameter	Symbol	Ratings	Unit
Forward Current	IF	W1+W2=3000*2	mA
Reverse Voltage	VR	Not designed for reverse operation	V
Power Dissipation	PD	50	W
Junction Temperature	Tj	150	°C
Electrostatic Discharge Threshold (ESD)	ESD	2000	V
Storage Temperature	Tstg	-40~+70	°C
Operation Temperature	Topr	-30~+125	

**Notes:**

- Specifications are subject to change without notice.
- The data on this specification is for reference only and the actual data is in accordance with the acknowledgment.
- Precautions for ESD:  
STATIC SHIELD Electricity and surge damages the LED. It is recommended to use a wrist band or anti-electrostatic glove when handling the LED. All devices, equipment and machinery must be properly grounded.

**Electrical Optical Characteristics (Tc=25°C)**

Parameter	Symbol	Condition	Emitting color	Min.	Typ.	Max.	Units
Luminous Flux	$\phi_v$	If=2500mA	W1	2800	3000	3200	lm
			W2	2800	3000	3200	
Forward Voltage	$V_f$		W1	8.9	9.3	9.8	V
			W2	8.9	9.3	9.8	
Correlated Colour Temperature	CCT	If=1000mA	W	5000	5500	6000	K
Viewing Angle at 50% IV	$2\theta_{1/2}$	—	W	—	120	—	Deg
Reverse Current	$I_R$	—	W	—	—	—	$\mu A$
Thermal Resistance Junction to Case	$R\theta_{J-C}$	If=2500mA	—	—	0.14	—	K/W
Temperature Coefficient of Voltage	$V\Delta F/T$		—	—	-7.5	—	mV/°C

**White Color coordinate filing (IF=1000mA )**

Region	CCT Range		X1	Y1	X2	Y2	X3	Y3	X4	Y4
	Min	Max								
H11	5000K	5300K	0.3467	0.3741	0.3376	0.3644	0.3381	0.3793	0.3475	0.3896
G12	5300K	5700K	0.3374	0.3592	0.3276	0.3470	0.3273	0.3620	0.3380	0.3757
G10	5700K	6000K	0.3277	0.3432	0.3218	0.3369	0.3207	0.3501	0.3274	0.3571

**Notes:**

- Luminous intensity is measured with a light sensor and filter combination that approximates the CIE eye-response curve.
- $\theta_{1/2}$  is the off-axis angle at which the luminous intensity is half the axial luminous intensity.
- The dominant wavelength ( $\lambda_d$ ) is derived from the CIE chromaticity diagram and represents the single wavelength which defines the color of the device.
- Luminous flux measurement tolerance:  $\pm 15\%$ .
- Forward voltage measurement tolerance:  $\pm 0.15V$ .

Part No.	TX-7070W48FSB3-NU3CH-01	Spec No.	WKF-EK0022	Page	4 of 9
----------	-------------------------	----------	------------	------	--------

## Typical Electrical/Optical Characteristics Curves

(25°C Ambient Temperature Unless Otherwise Noted)

Forward Current VS. Forward Voltage

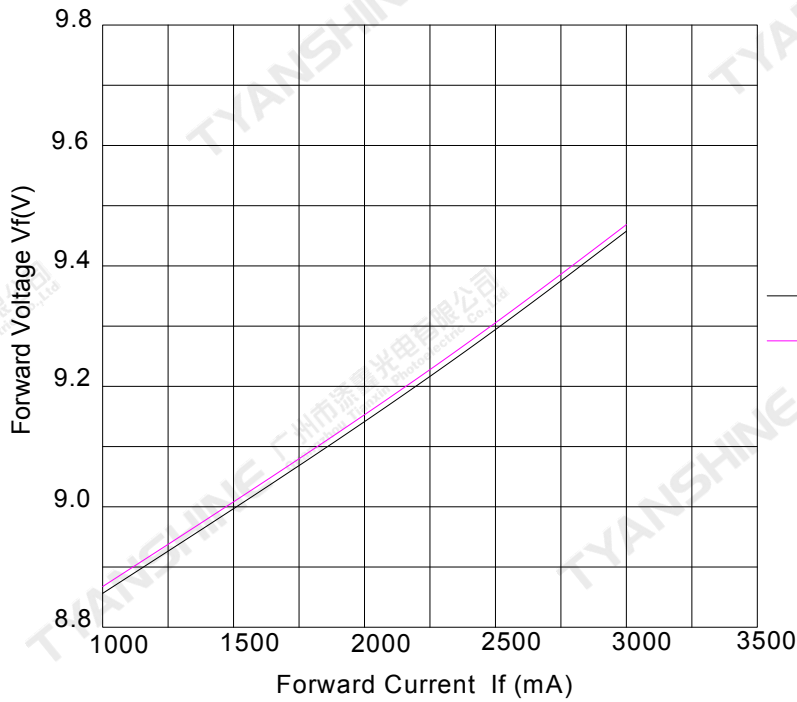

Forward Current VS. Luminous flux

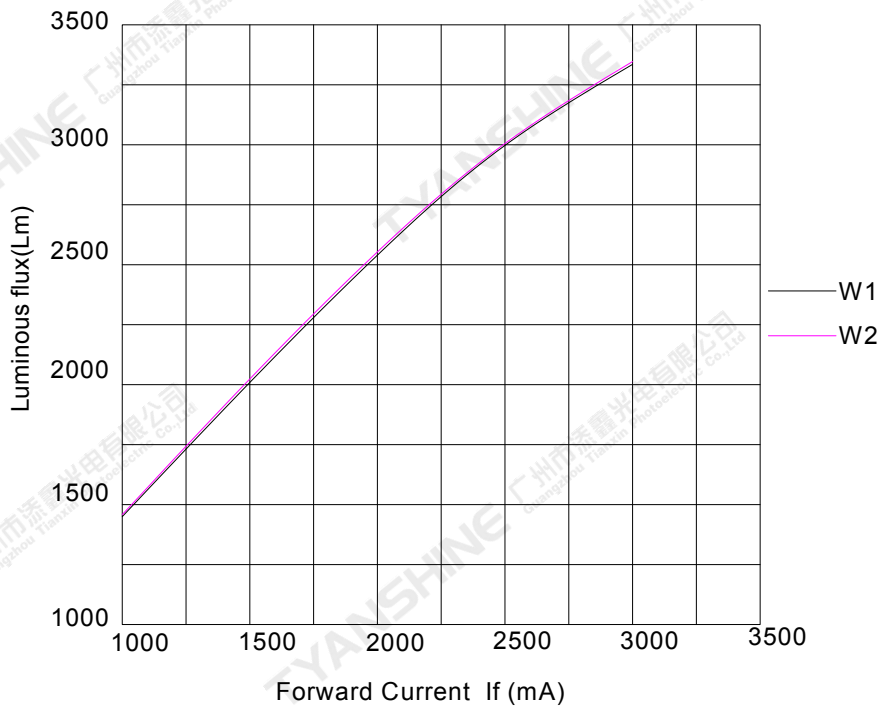

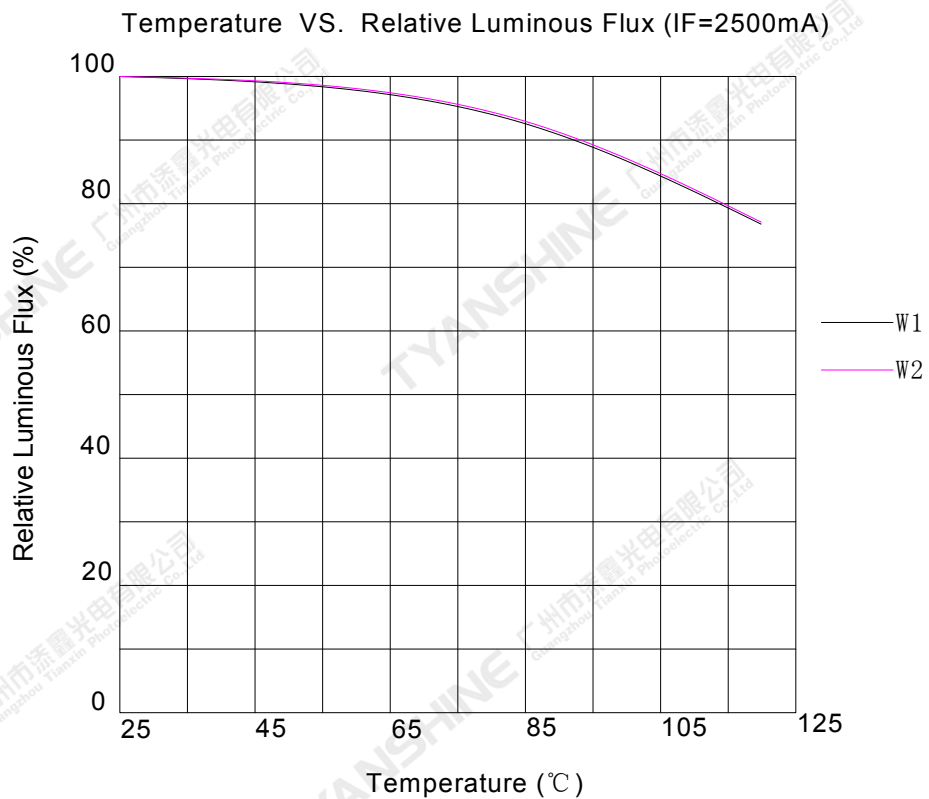
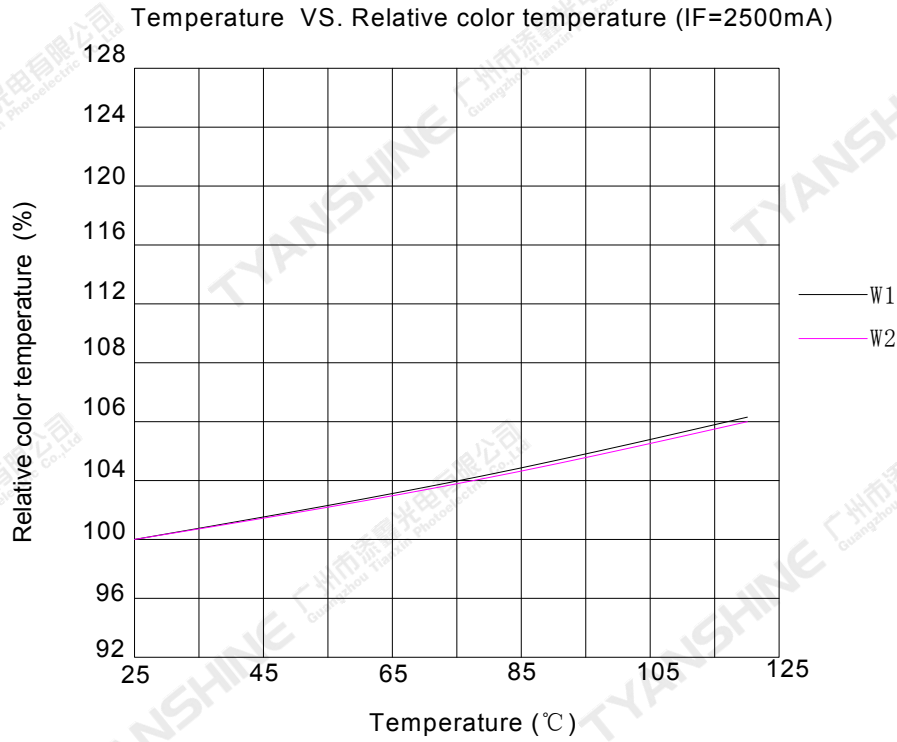

**Relative Spectral Distribution**

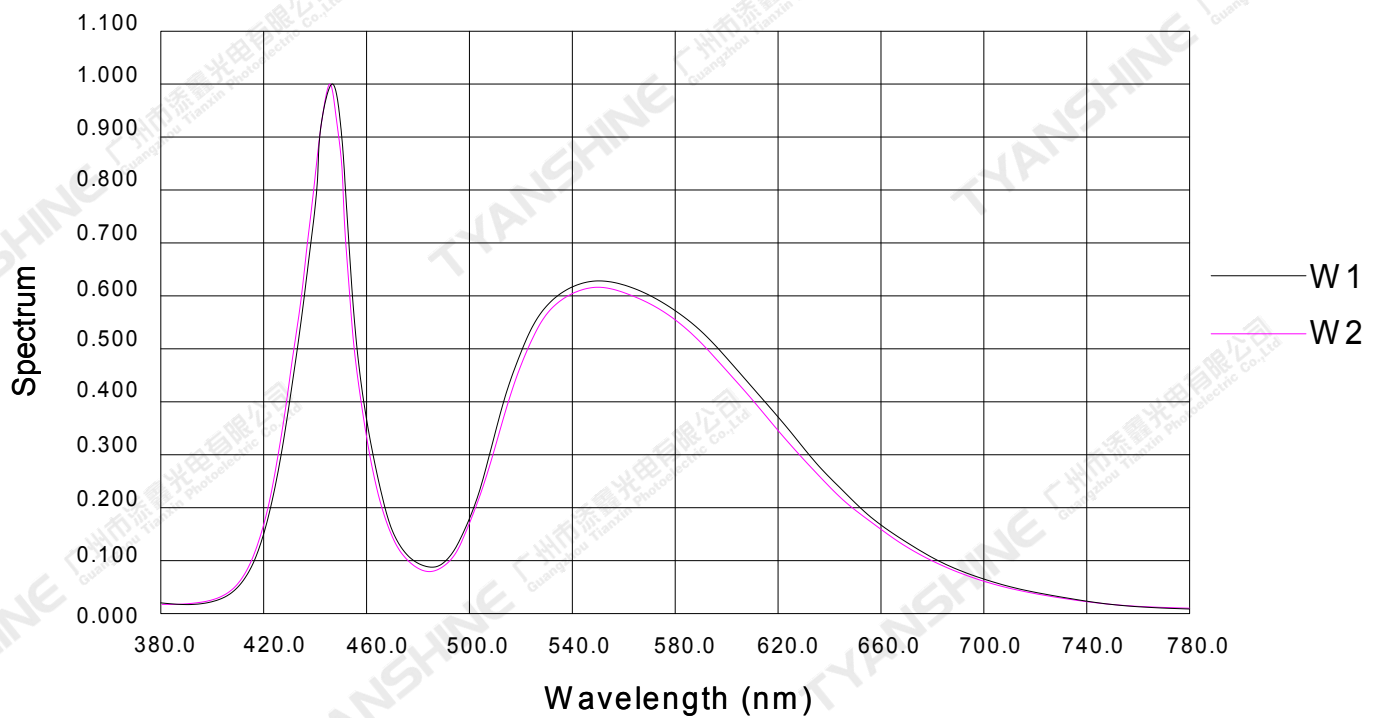

**Beam Pattern**

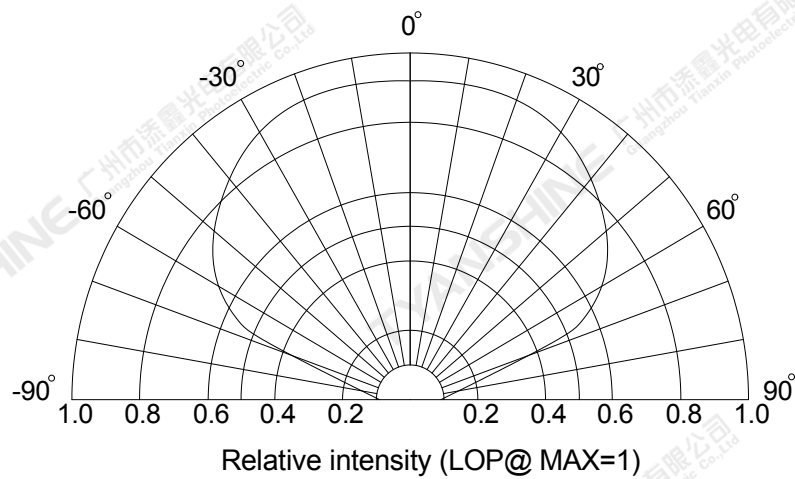

**Notes:**

1.  $2\theta_{1/2}$  is the off axis angle from lamp centerline where the luminous intensity is 1/2 of the peak value.
2. View angle tolerance is  $\pm 5^\circ$ .

Part No.	TX-7070W48FSB3-NU3CH-01	Spec No.	WKF-EK0022	Page	7 of 9
----------	-------------------------	----------	------------	------	--------

## Usage Precautions

### Storage Environment Condition

Temperature: 5°C ~ 30°C (41°F ~ 86°F)

Humidity: 60% RH Max.

### Soldering Condition

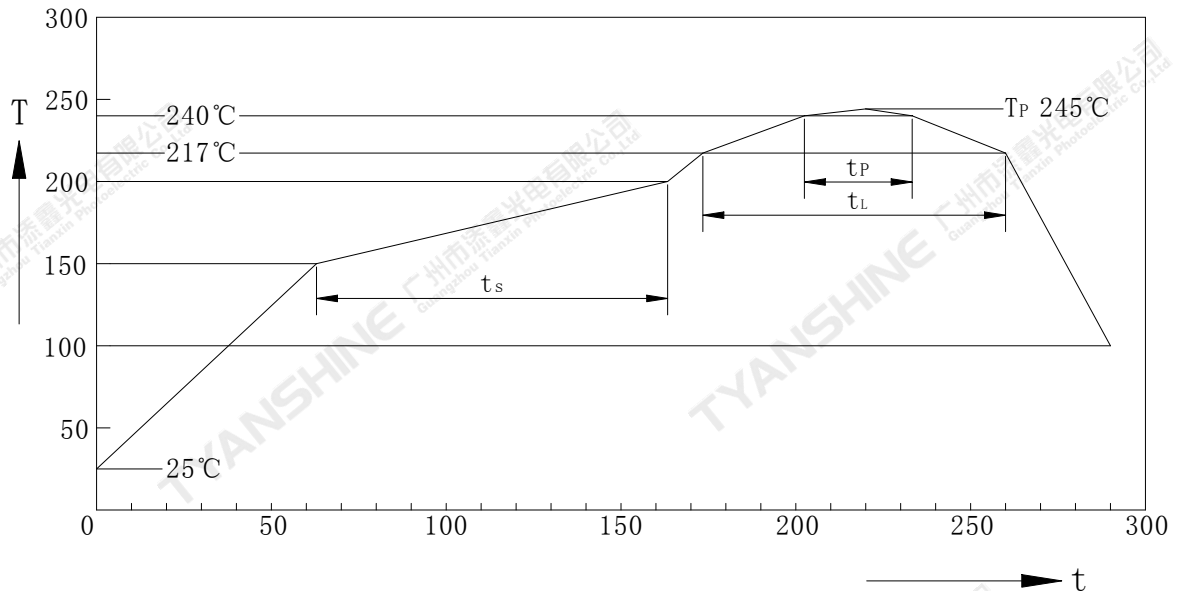

Profil-Charakteristik Profile Feature	Symbol	Pb-Free(SnAgCu)Assembly			Einheit Unit
		Minimum	Recommendation	Maximum	
Ramp-up Rate to Preheat 25°C to 150°C	-	-	2	3	K/s
Time $t_s$ $T_{Smin}$ to $T_{Smax}$	$t_s$	60	100	120	s
Ramp-up Rate to Peak $T_{Smax}$ to $T_p$	-	-	2	3	K/s
Liquidus Temperature	$T_L$	217			°C
Time above Liquidus temperature	$t_L$	-	80	100	s
Peak Temperature	$T_P$	-	245	260	°C
Time within 5°C of the specified peak temperature $T_p-5$ K	$t_p$	10	20	30	s
Ramp-down Rate $T_p$ to 100°C	-	-	3	6	K/s
Time 25°C to $T_p$	-	-	-	480	-

#### Note:

All temperatures refer to topside of the package, measured on the package body surface.



**Dimensions For Cannulation And Packaging**

**Quantity: 1000PCS**

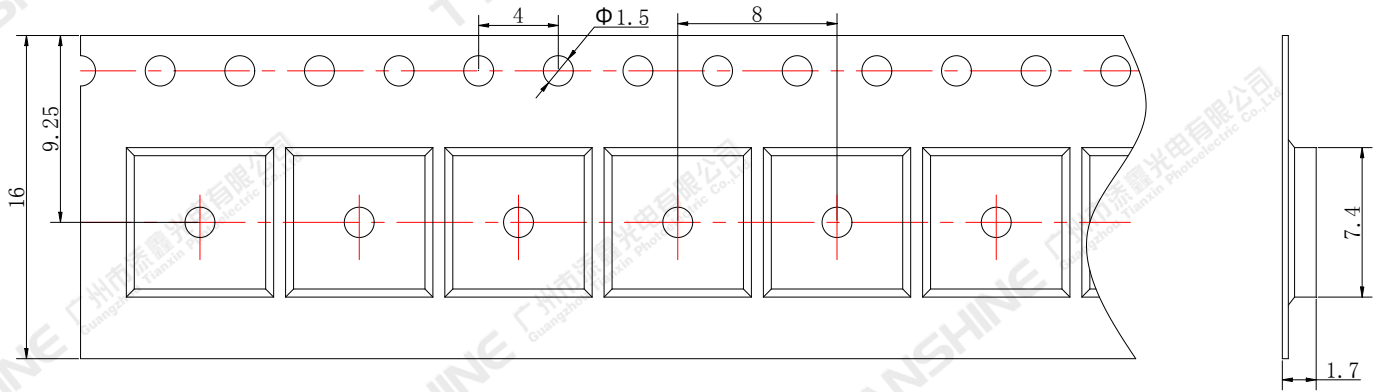

**Notes:**

1. All dimensions are in millimeters.
2. Tolerances are  $\pm 2.0$  mm unless otherwise noted.
3. The products are packaged together with silica gel, Transport, not to the weight of welding LED light-emitting area, As a result of the weight of LED light-emitting zone in the quality of, Irresponsible of the Company.

Part No.	TX-7070W48FSB3-NU3CH-01	Spec No.	WKF-EK0022	Page	9 of 9
----------	-------------------------	----------	------------	------	--------